

Rozměry v mm  
Maße in mm  
Dimensions in mm

Heat U 3g L 50.52.50.21  
240kg

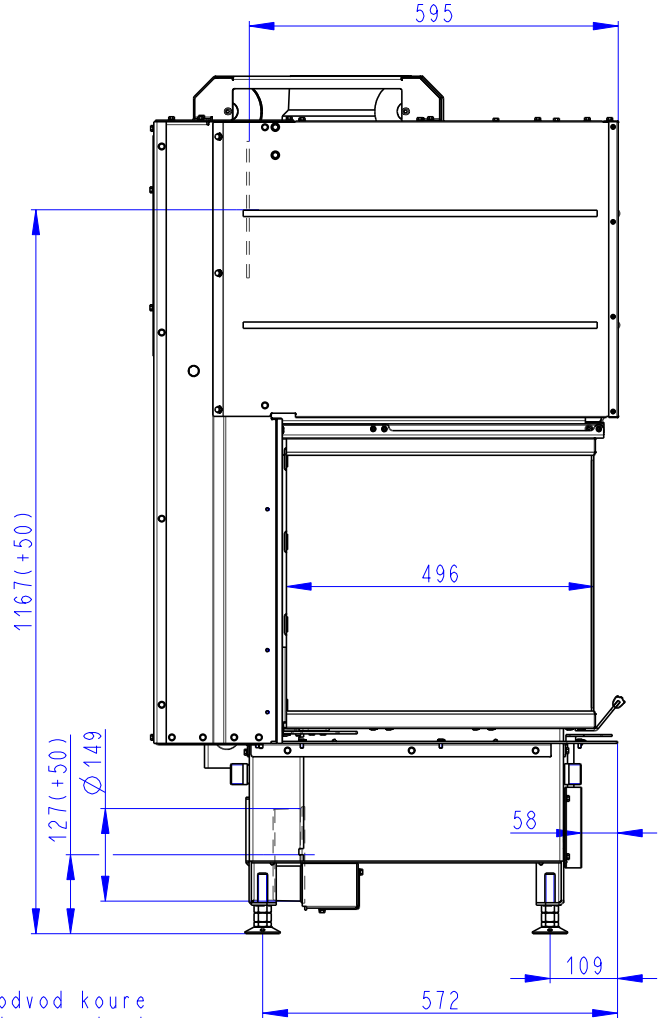

Litvinový odvod kouře  
Cast iron spigot  
Der gusseiserne Rauchabgang

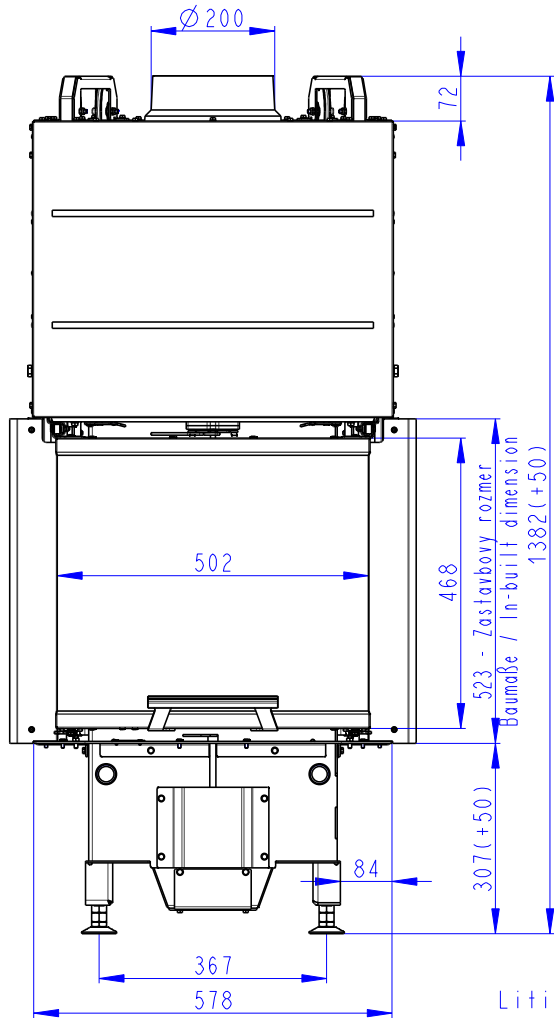
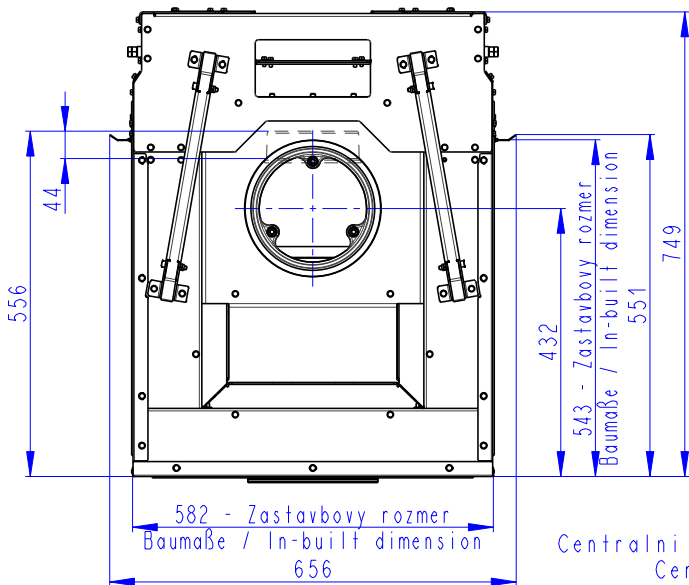

Centralni prived vzduchu  
Central air inlet  
Zentralluftzufuhr

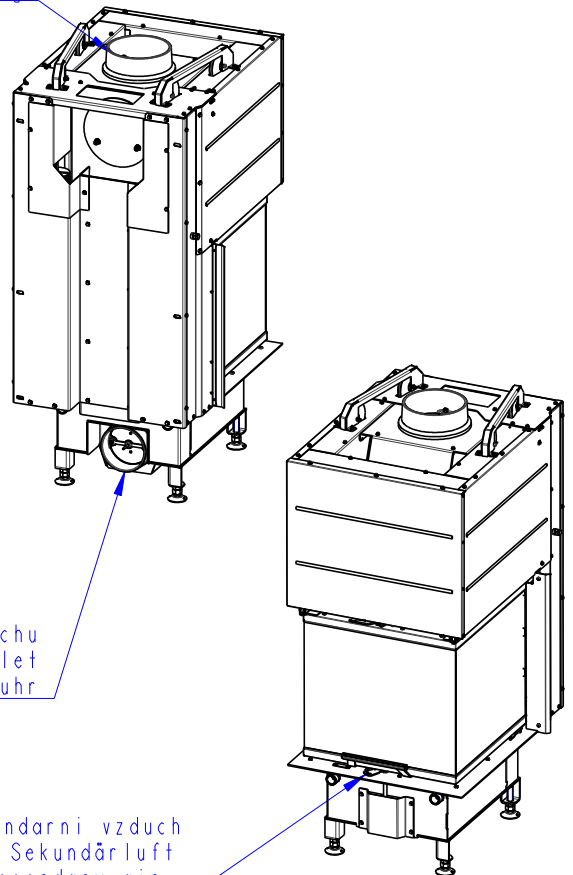

Primarni a sekundarni vzduch  
Primärluft und Sekundärluft  
Primary and secondary air

Rozměry v mm  
 Maße in mm  
 Dimensions in mm

Heat U 3g L 50.52.50.21 K1  
 275kg

